

Linear Choke, high design



Description

- Linear choke
- THT-terminals
- Inductor vertically positioned in housing

Standards

- EN 60938

Applications

- Smoothing RFI suppression choke
- RFI suppression choke
- Chopper amplifiers
- DC drives and stepper motor controls
- Switching power supplies

References

[General Product Information](#)

Weblinks

[Approvals](#), [RoHS](#), [CHINA-RoHS](#), [e-Store](#), [Distributor-Stock-Check](#)

Technical Data

Rated voltage	up to 600 VDC
Rated Current	0.45 - A @ Ta 70 °C
Rated inductance	0.02 - 5.5 mH, Tol. ±15%
Power Operating Frequency	up to 20 kHz
Terminal technic	THT
Weight	4 - 38 g
Material: Housing	UL 94V-0
Sealing Compound	UL 94V-0

Isolation Voltage	2 kV eff., winding to ambient
Climatic Category	40/125/21 acc. to IEC 60068-1
Allowable Operation Temp.	-40 °C to 125 °C

Dimensions

Case 01-1

Case 09-1

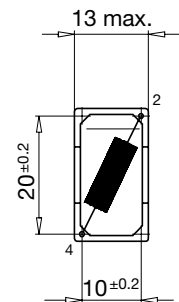
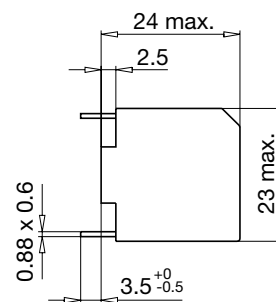
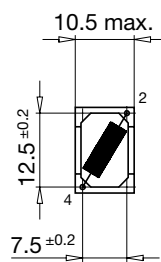
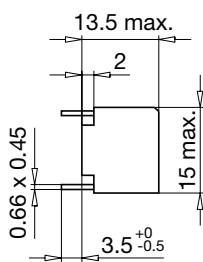

Case 19-1

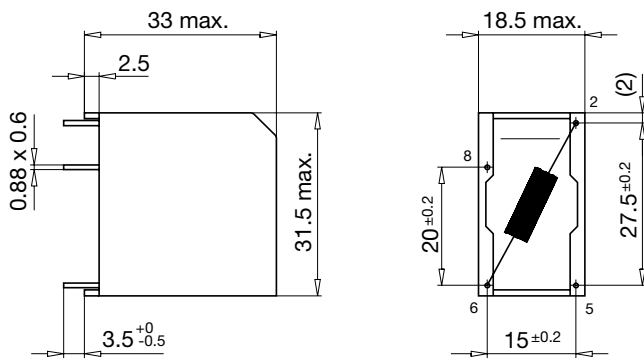

Diagrams

Application in DC-DC Converter

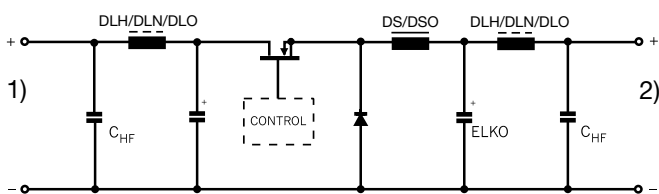

- 1) DC-Input unregulated
- 2) DC-Output regulated

Derating Curves

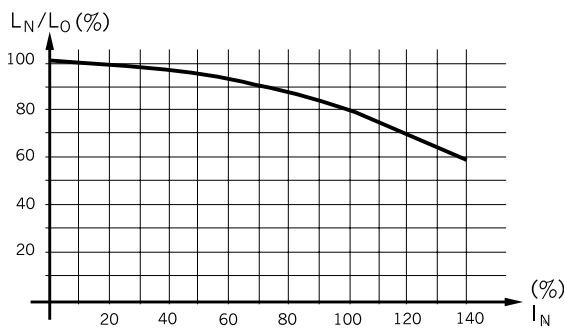

Inductance variation as function of the magnetizing current

Variants

I_n [A]	L_n [mH]	R_{cu} [mΩ]	f_{RES} [MHz]	Weight [g]	Housing	Packing unit [pcs.]	Order Number
0.6	0.5	750	1.6	4	01-1	100	DLH-14-0001
1	0.2	220	6	4	01-1	100	DLH-14-0002
2	0.05	50	9	4	01-1	100	DLH-14-0003
0.45	5	2600	0.2	14	09-1	50	DLH-22-0001
0.6	3	1550	0.3	14	09-1	50	DLH-22-0002
1	0.5	0.3	1	14	09-1	50	DLH-22-0003
1.5	0.5	280	1	14	09-1	50	DLH-22-0004
1.8	0.3	180	1.5	14	09-1	50	DLH-22-0005
3	0.1	70	4	14	09-1	50	DLH-22-0006
4.5	0.05	30	6	14	09-1	50	DLH-22-0007

I_n [A]	L_n [mH]	R_{cu} [mΩ]	f_{RES} [MHz]	Weight [g]	Housing	Packing unit [pcs.]	Order Number
7	0.02	12	15	14	09-1	50	DLH-22-0008
0.6	5.5	3600	0.2	38	19-1	70	DLH-31-0001
1	2.0	70	4	38	19-1	70	DLH-31-0002
1.6	0.8	470	1.5	38	19-1	70	DLH-31-0003
2	0.5	300	2	38	19-1	70	DLH-31-0004
2.5	0.3	160	3	38	19-1	70	DLH-31-0005
3.15	0.2	109	5	38	19-1	70	DLH-31-0006
4	0.13	53	6	38	19-1	70	DLH-31-0007
6.3	0.05	23	9.5	38	19-1	70	DLH-31-0008